

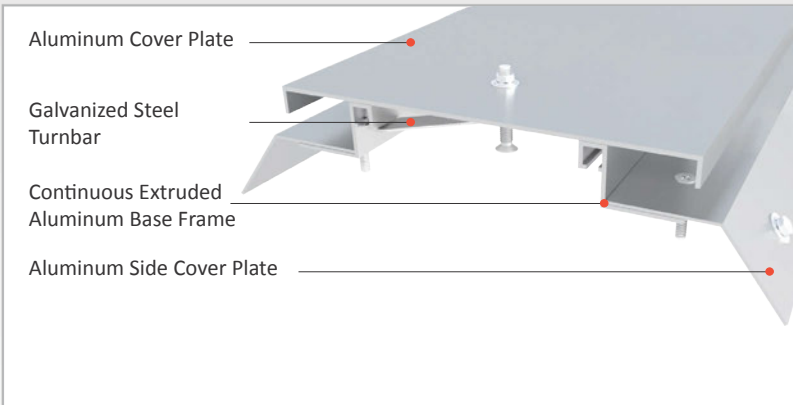

AS SHP roof covers are placed on the parapet walls to eliminate the penetration of water, wind and other factors through the expansion joint openings at the roofs. Seismic covers are designed for flat roofs and can compensate thermal, structural and seismic movements. During the seismic based activity, owing to specially designed mechanism AS SHP meets the displacements and ensures the cover plate to stay in its original position after activity is over. Anodized or powder coated finish gains the application areas an aesthetic view.

- Application Areas** : Indoor & Outdoor / Roof
- Ideal for** : All buildings with flat roof
- Material** : Aluminum (Extruded and Hot or Cold Rolled)
- Aluminum Alloy** : Visible parts anodized or powder coated, Mill Finish Base Frame
- Optional Supplies** : Waterproof EPDM membrane



SEISMIC

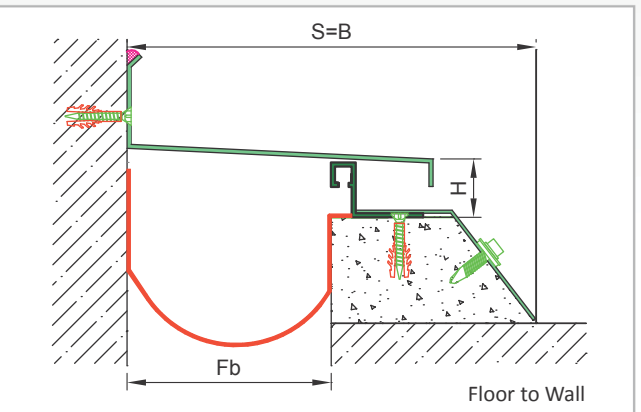
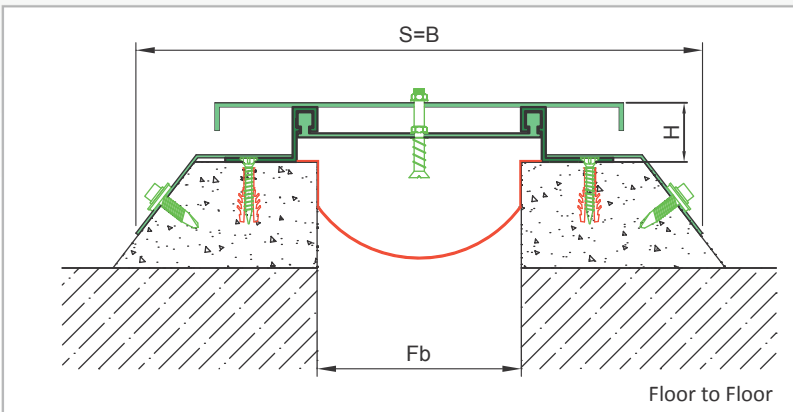

* Visuals are representative and the profile configuration may differ depending on the characteristics requested.

LOCATION	MODEL	GAP (Fb) mm	HEIGHT (H) MM	OVERALL WIDTH (B) mm	VISIBLE WIDTH (S) mm	WALL THICKNESS mm	MOVEMENT (W) mm	STANDARD LENGTH (mt)
Floor to Floor	AS SHP 050	50	27	230	230	100	+25/-40	3
	AS SHP 060	60	27	240	240	110	+30/-45	3
	AS SHP 100	100	27	280	280	150	+45/-70	3
	AS SHP 120	120	27	300	300	170	+55/-85	3
Roof to Wall	AS SHP 050K	50	27	140	140	100	+35/-50	3
	AS SHP 060K	60	27	150	150	110	+35/-60	3
	AS SHP 100K	100	27	190	190	150	+35/-100	3

Note: Please ask for different sizes

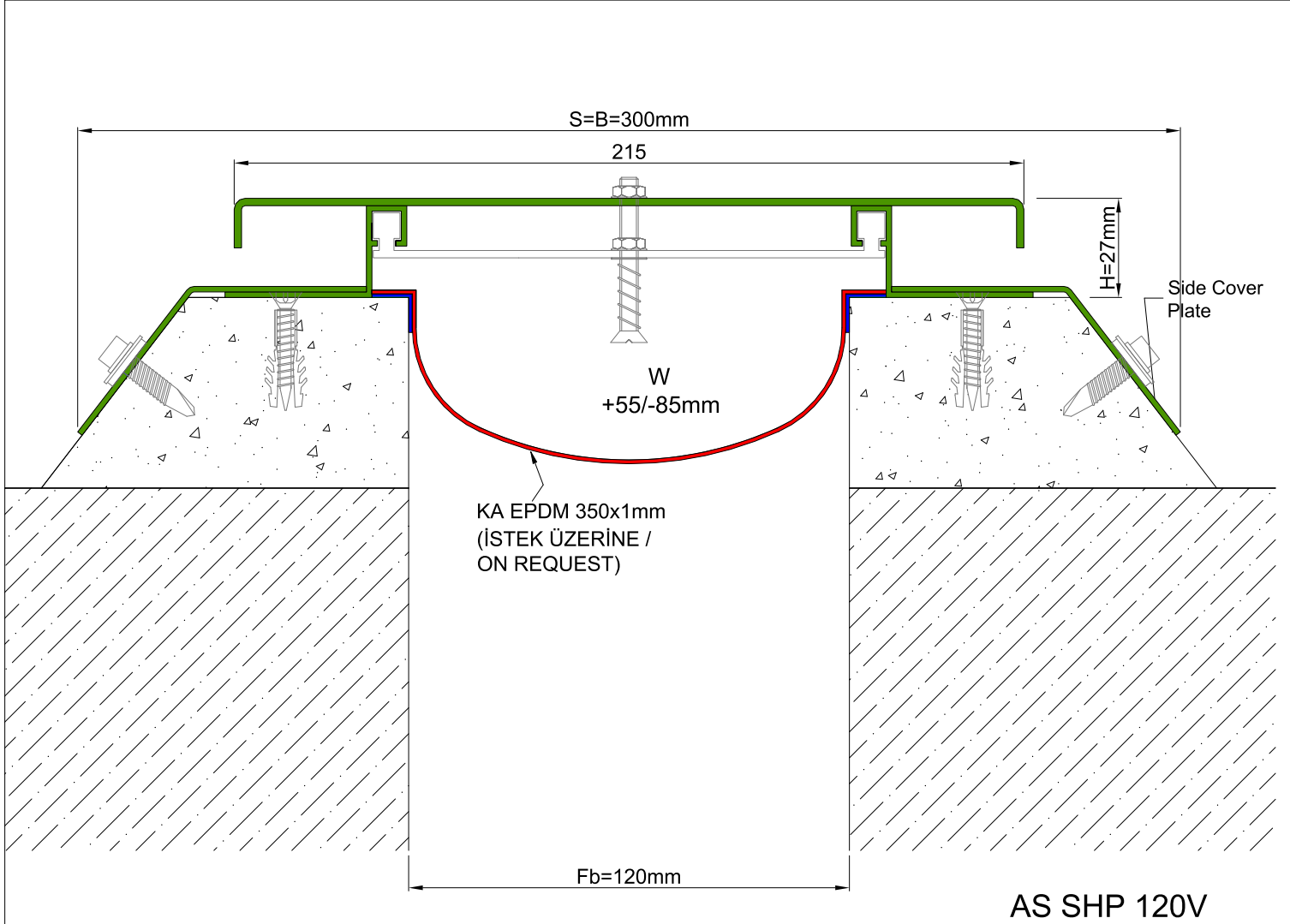

Profil No Profile Number	AS SHP 120 V
Fb (mm)	120
H (mm) yaklaşık approx.	27
W± (mm) yaklaşık approx.	+55/-85
Renk Color	Alüminyum Görünür Yüzeyler: Elokssalli, Alüminyum Bağlantı Elemanı: Natürel Aluminum Visible Parts: Anodized, Aluminum Base Frame: Natural
Malzeme Material	Alüminyum Aluminum
Standart Uzunluk Standard Length	3